



Level E Homework 1

Whole Number and Time Chapters

Show your working

- Q1. (a) $5638 + 8474$ (b) $20000 - 14950$
- Q2. (a) 205×100 (b) $79000 \div 1000$
- (c) A jar contains 99 sweets. How many are in 100 jars?
- Q3. (a) 748×8
- (b) There are 3600 seconds in an hour. How many are there in 5hrs?
- Q4. (a) $5 \overline{)2105}$ (b) $\frac{1920}{8}$
- (c) Table-tennis balls are packed in boxes of 8. How many boxes are needed for 1000 balls?
- (d) How many are left over?
- Q5. (a) 3000×42 (b) $150000 \div 300$
- Q6. Convert to the 24-hour clock.
- (a) 3:25 pm (b) 6:15 am
- (c) Paul beat Bernard by 2.82 seconds in the 100metres hurdles. Paul's time was 12.29 seconds. What time did Bernard take?



Q1. What **types** of angles are shown below?

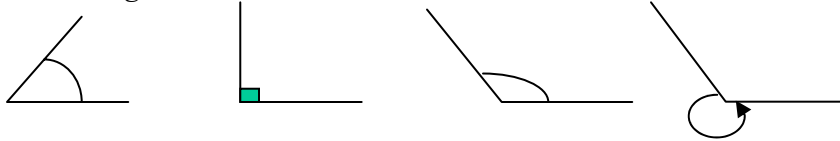

Q2. Using 3 CAPITAL letters **name** all the angles in the triangle below?

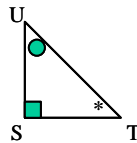

Q3. Copy the diagram and fill in all the missing angles: -

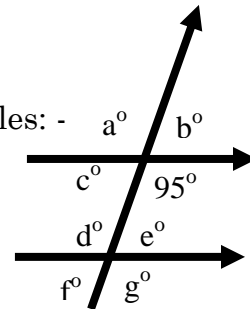

Q4. Round the following numbers to 1 decimal place.

- (a) 0.625 (b) 23.675 (c) 45.555

(ii) What value is the arrow pointing at?

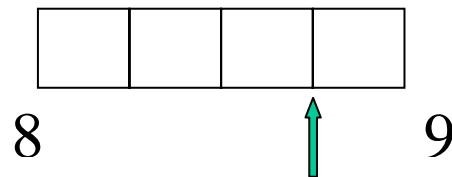

Q5. Multiply the following numbers by 1000.

- (a) 24.785 (b) 13.5 (c) 0.0045

(ii) Divide the following numbers by 100.

- (a) 615.4 (b) 17.5 (c) 0.7

Q6. (a) 7.8×7 (b) $1.84 \div 8$

- (c) 8 packets of flakes weigh 444.8 grams.
What is the weigh of 1 packet?



www.mathsrevision.com

Level E Homework 3

Prime Numbers and Fractions & Percentage

Show your working

- Q1. Is 37 a prime number. Explain your answer?
- Q2. What is the highest common factor of the numbers 6 and 8?
- Q3. What is the lowest common multiple of the numbers 6 and 8?
- Q4. Convert the following fractions to percentages.
- (a) $\frac{3}{10}$ (b) $\frac{3}{5}$ (c) $\frac{1}{8}$
- (ii) Convert the following percentages to fractions and simplify where possible?
- (a) 75% (b) 40% (c) 3.5%
- Q5. Find.
- (a) $\frac{3}{5}$ of £60 (b) 32% of £300
- Q6. (a) Ian scored 24 out of 30 in a Maths test and 50 out of 60 for his History test. What was his percentage score in each exam?
- (b) Which subject is he best at.



Q1. Find the mean and range of the set of numbers below

25, 20, 50, 70, 35

Q2. Calculate

(a) $3-9$

(b) $-19+11$

(c) $-6-17$

(d) $-12+(-14)$

Q3. Copy out the coordinate diagram and plot the points

A(4,-2)

B(-3,2)

C(-2,-1)

(ii) Join the points together, what shape do you get.

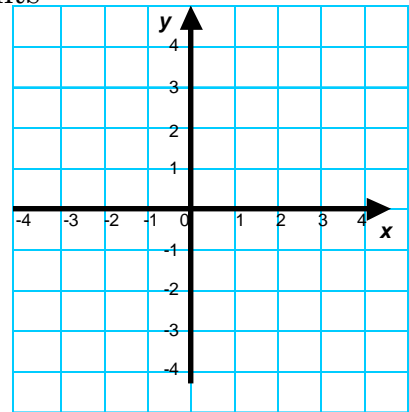

Q4. Tidy up the expressions

(a) $2x+6y+3x+7y$

(b) $a+b+a^2+3b+5a+b^2$

Q5. For $a=5$ $y=3$ $t=2$ find

(a) $3at-y$

(b) $\frac{1}{2}ayt-at$

Q6. (a) Find an expression for the total T cost of the fruits below.

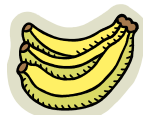
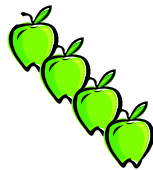

(b) If an apple costs 26p and a banana costs 32p what is the total cost T.



Q1. Solve the following equations:

(a) $x + 58 = 67$

(b) $7x = 84$

(c) $4x - 40 = 8$

(d) $3x - 11 = 13$

Q2. By picking from the following values $\{-2, -1, 0, 1, 2\}$ solve the following inequalities:

(a) $x > -2$

(b) $x \geq -1$

(c) $x \leq 0$

(d) $x < -2$

Q3. Solve the inequalities

(a) $x - 3 > 26$

(b) $2x > 38$

(c) $2x + 5 > 23$

Q4. Find the perimeter and area for the following shapes.

(a)

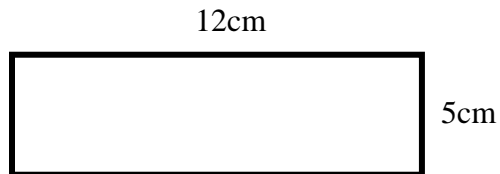

(b)

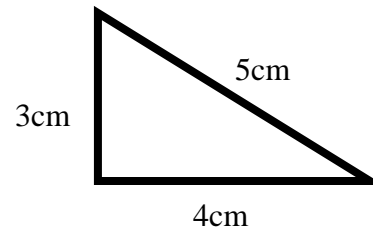



1. Name the given parts of the circle.
2. Write down the diameter of a circle if the radius is 7cm.
3. Write down the radius of a circle if the diameter is 6cm.

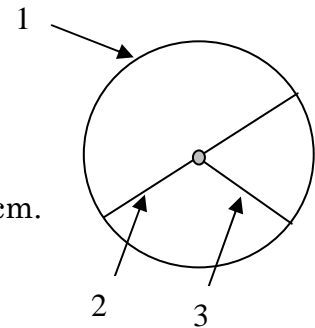

4. Complete the formula $C = ___ \times D$
5. If the diameter of a circle is 10cm. Calculate the circumference.
6. Copy and complete the shape so that it has half-turn symmetry about its centre.

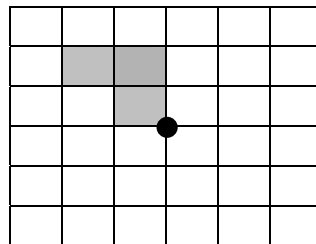

7. What is the order of symmetry for the following shapes?

(a)



(b)



(c)

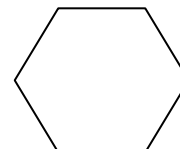



1. Copy out each shape and find its area. (Show your working)

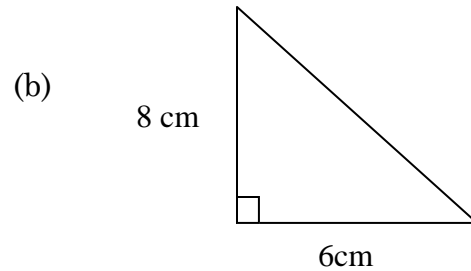
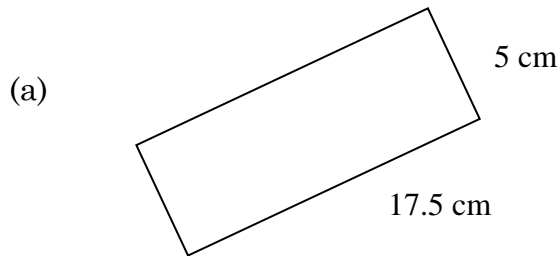

2. Copy out each composite shape and find its area. (Show your working)

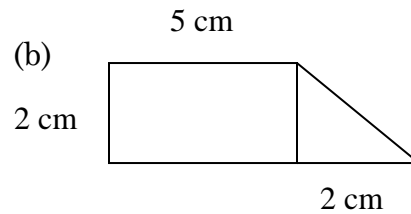
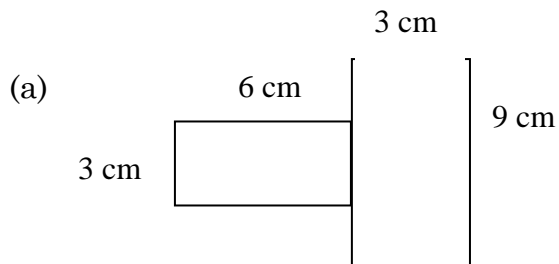

3. Copy out the L – shape plan of the lawn below. (Show your working)

Find the perimeter and total area of the lawn.

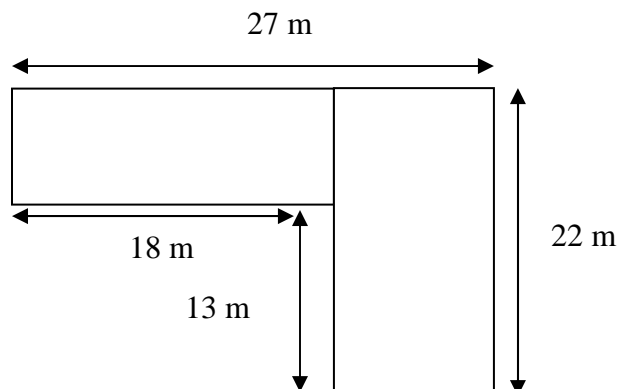



1. Find the next 3 numbers in each of the sequences.

(a) 6, 9, 12, ..., ..., ...

(b) 4, 8, 16, ..., ..., ...

(c) 77, 66, 57, ..., ..., ...

(d) 2, 3, 5, 7, 11, ..., ..., ...

2. Write down all the square numbers between 50 and 200.

3. Fill in the table and determine a formula connecting the two letters (T) and (L).



No of Tables (T)	1	2	3	4	5	6
No of Legs (L)	4	8	12	16	20	24

4. Determine a formula connecting the two letters (F) and (L).

Fish (T)	1	2	3	4
Litres (L)	26	51	76	101

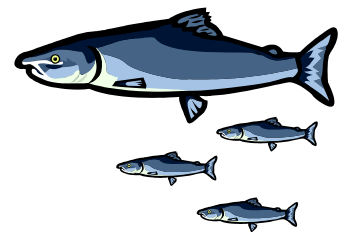



1. I have 2 pairs of parallel lines, 2 pairs of lengths that are equal, 4 right angles and 2 lines of symmetry. What is my shape?

2. Copy out the shapes and fill in as many angles.

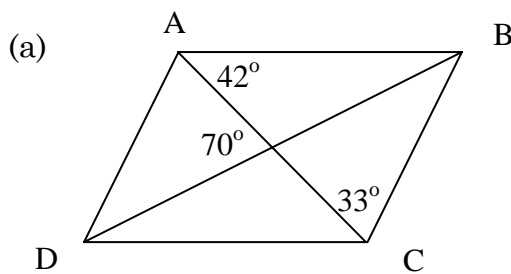

Parallelogram

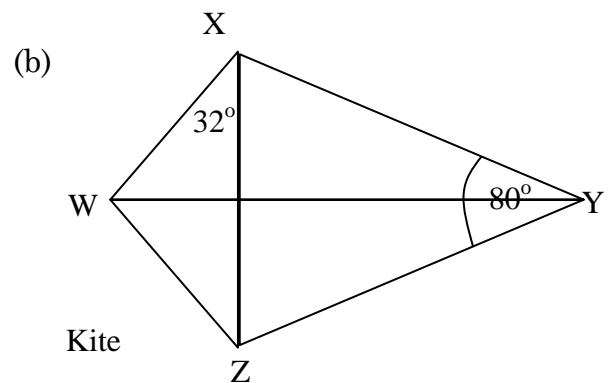

Kite

3. Simplify the following ratios

- (a) 4 : 20 (b) 3 : 27 (c) 7 : 84 (d) 12 : 108

4. The ratio of diesel to petrol cars is 4 : 7

(a) How many petrol cars are there if there are: -

- (i) 8 diesels (ii) 20 diesels

(b) How many diesel cars are there if there are: -

- (i) 18 petrol (ii) 84 petrol



Level E Homework 10

Scale Drawing and Volume

Show your working

1. The rectangle is drawn to the following scale $1\text{cm} = 20\text{cm}$.

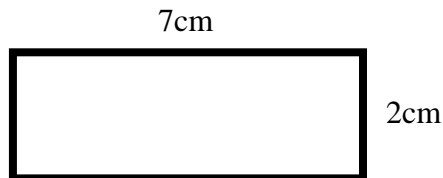

- (a) Find the real life length and breadth.
(b) What is the real life perimeter and area?

2. Find the volume of the following shapes.

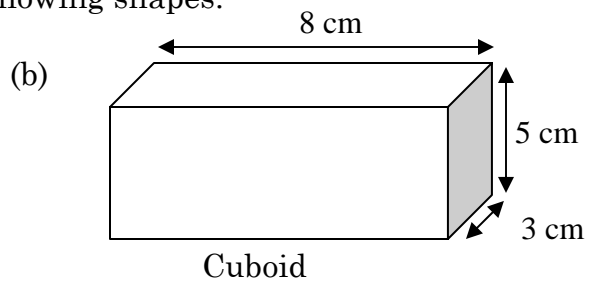
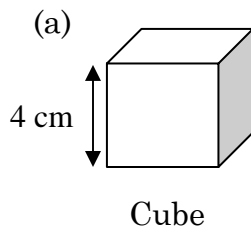

3. Find the volume of this composite shape.

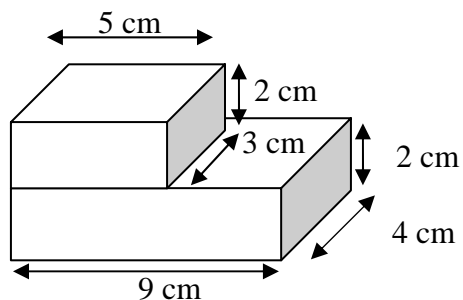



1. Calculate

(a) $12 - 23$ (b) $(-3) + 26$ (c) $(-11) - 45$

2. Solve the equations

(a) $6x + 5 = 23$ (b) $8x = 120$

3. Find

60% of £540

4. Find

(a) The length of the rectangle below.

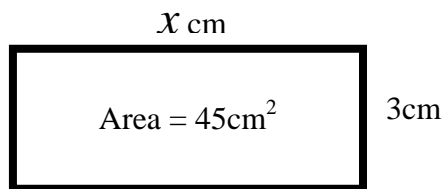

(b) The perimeter.

5. Find a formula connecting table (T) and chairs (C).

No. of Tables (T)	1	2	3	4
No. of Chairs (L)	4	7	10	13

